



Technische  
Universität  
Braunschweig

**CONCERT JAPAN**  
Connecting and Coordinating  
European Research and Technology Development with Japan



Leichtweiß-Institute for Hydraulic Engineering and Water Resources  
Department for Hydromechanics and Coastal Engineering



## Summary of laboratory experiments at LWI (WP3)

Agnieszka Strusińska-Correia, Andreas Kortenhaus  
RAPSODI Project meeting | 5.-6. March 2015 | LWI, TU Braunschweig, Germany

# Content

1. Motivation and objectives
2. Experimental set-up and programme
3. Results
4. Conclusions

# Content

1. Motivation and objectives
2. Experimental set-up and programme
3. Results
4. Conclusions

# TU-BS contribution

## **STAGE 1: Evaluation of existing knowledge and comparison of mitigation strategies**

WP1: Evaluation of existing tools, data, and mitigation strategies (METU)

## **STAGE 2: Numerical and experimental studies**

WP2: Numerical modelling of tsunamis (METU)

WP3: Laboratory experiments on tsunami impact on structures (TU-BS)

## **STAGE 3: Methodology for tsunami vulnerability assessment and risk management**

WP4: Development of a risk assessment model (NGI)

WP5: Development of mitigation strategies (PARI)

WP6: Networking and dissemination (NGI)

# Objectives

## WP3: Laboratory experiments on tsunami impact on structures:

- based on failure analysis of existing structures in Japan → failure matrix (METU)
- experimental investigation on tsunami-induced damage/forces on coastal structures
- experimental investigation on performance of innovative structures



TU-BS + METU

- Improvement of knowledge on structure failure under tsunami impact
- Development of innovative protective structures against tsunami
- Comparison with PARI experiments and their extension

# Content

1. Motivation and objectives
2. Experimental set-up and programme
3. Results
4. Summary and outlook

# Wave flume geometry at LWI

Length: ca. 90.0 m

Depth: ca 1.25 m

Width: 2.0 and 1.0 m

## RAPSODI experiments:

- 2.0 m wide flume
- Solitary waves and tsunami bores
- Model scale 1:30 (Froude similitude law)
- Breakwater geometry → simplified geometry of the breakwater at Haydarpasa Port, Turkey





# Tested breakwater configurations (1)

## Configuration 1 (crown wall and berm)

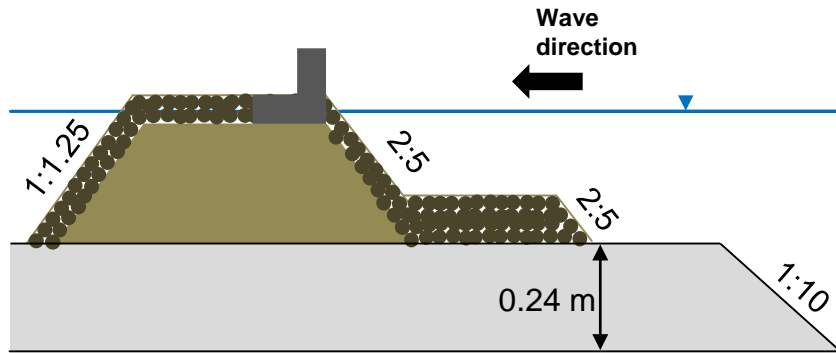

## Configuration 2 (without crown wall)

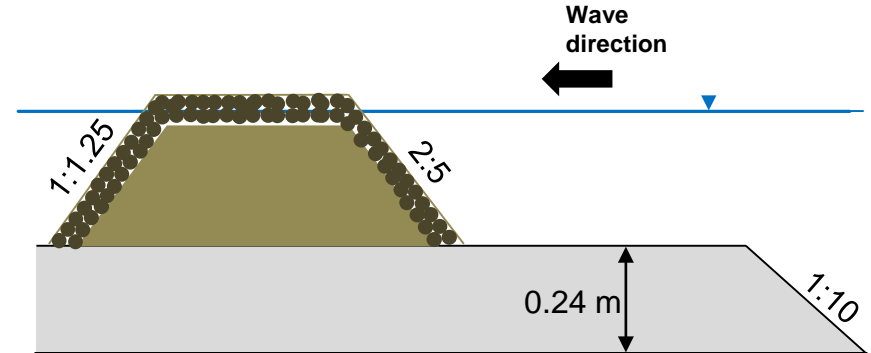

## Configuration 3 (crown wall)

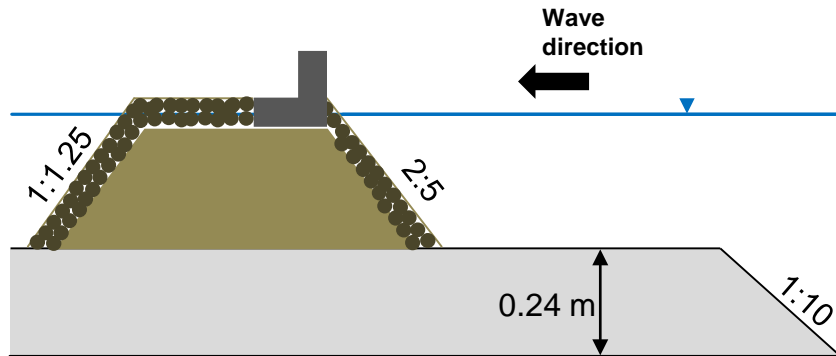

## Configuration 4 (shifted crown wall)

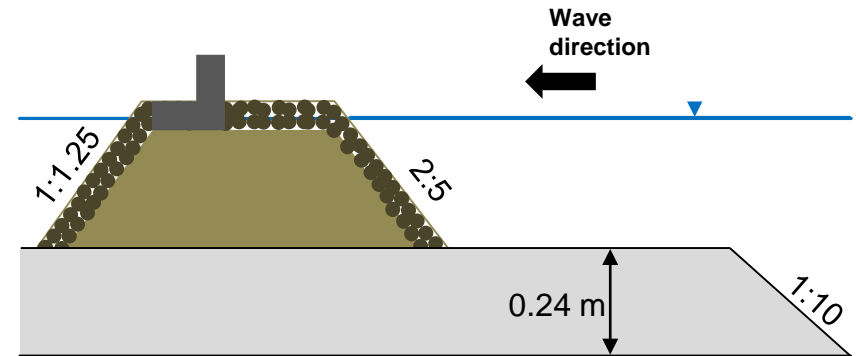



# Tested breakwater configurations (2)

## Configuration 1 and 2



## Configuration 3 and 4



# Breakwater layers

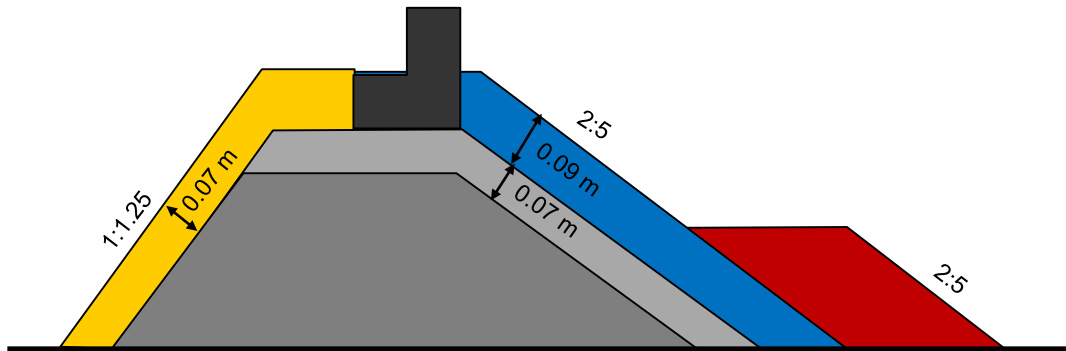

- Armour layer on the seaside (100 – 150 g)
- Armour layer on the harbour side (50 – 100 g)
- Berm (100 – 150 g)
- Filter layer (50 – 100 g)
- Core layer (0 – 10 g)
- Concrete crown wall

Core layer (0-10 g)



Filter layer (50-100 g)  
Harbour side armour



Seaside armour (100-150 g)  
Berm layer



# Breakwater geometry

## Configuration 1

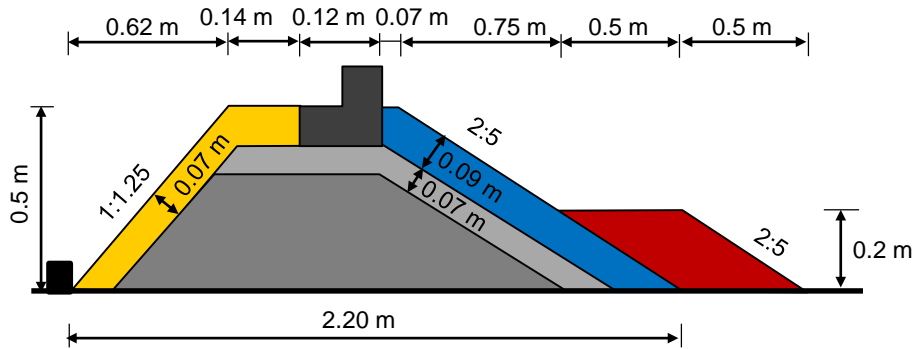

## Configuration 2

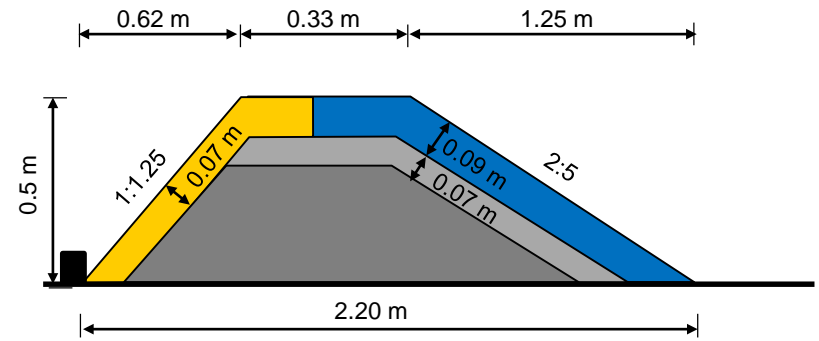

## Configuration 3

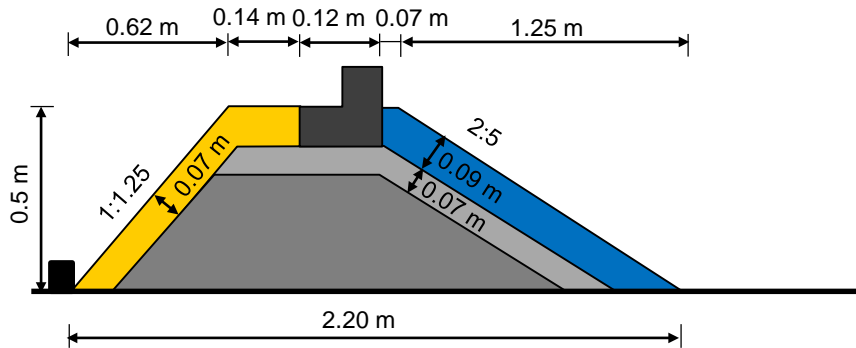

## Configuration 4

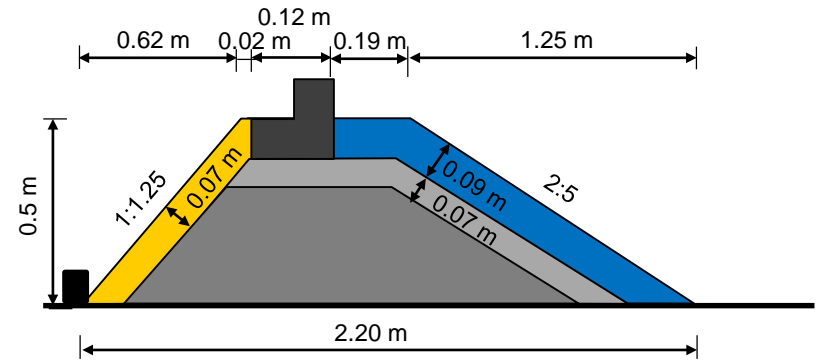

# Measuring instrumentation (1)

## Configuration 1

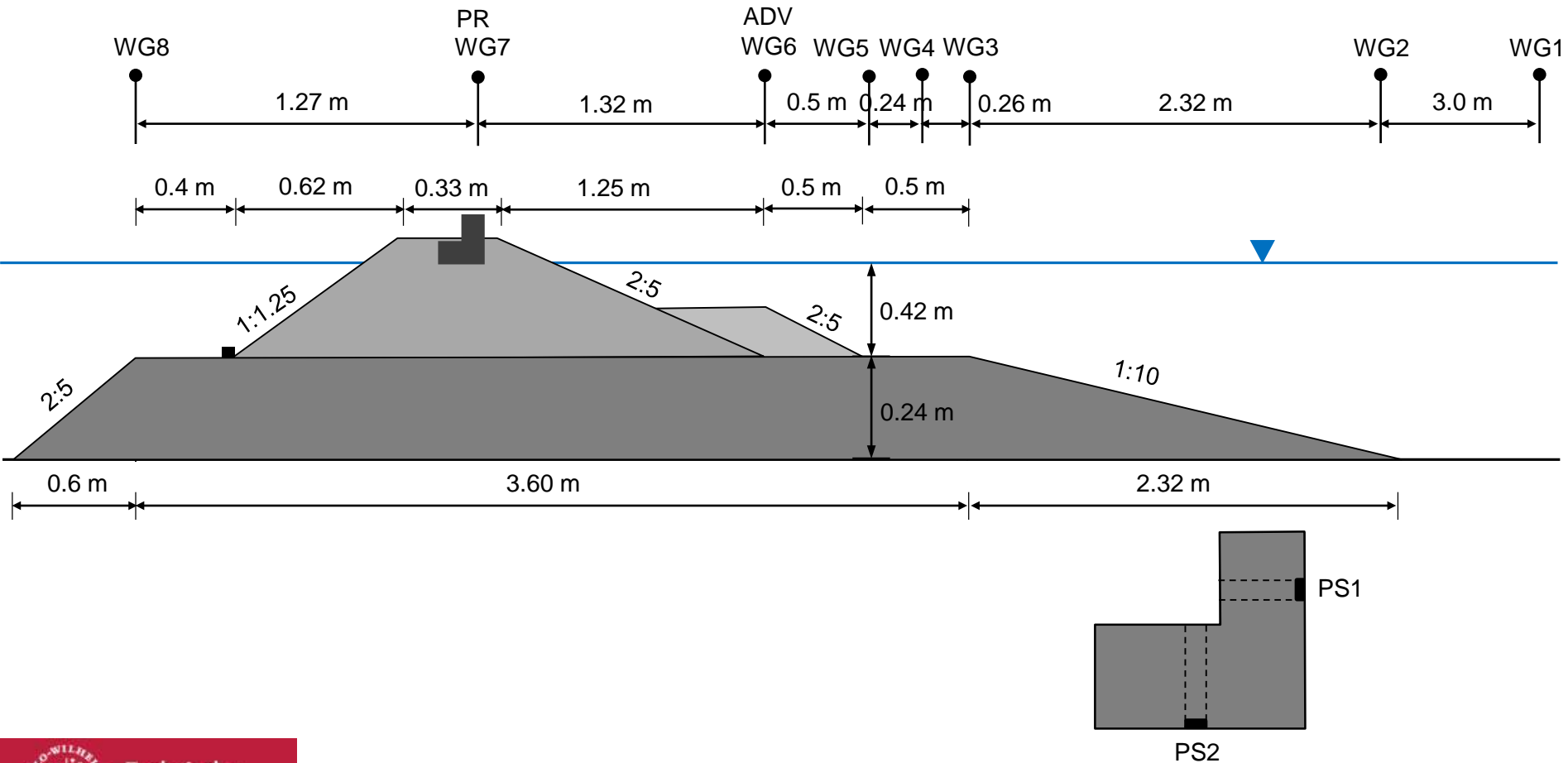



## Measuring instrumentation (2)

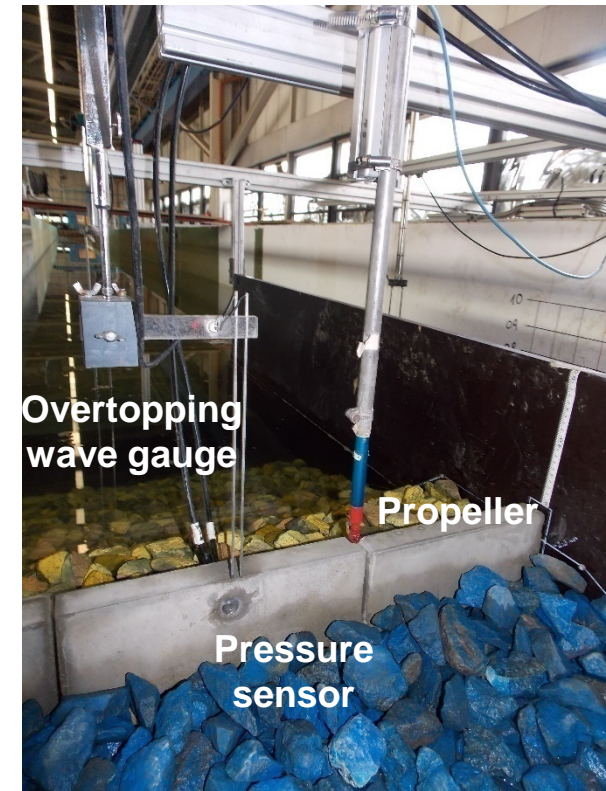
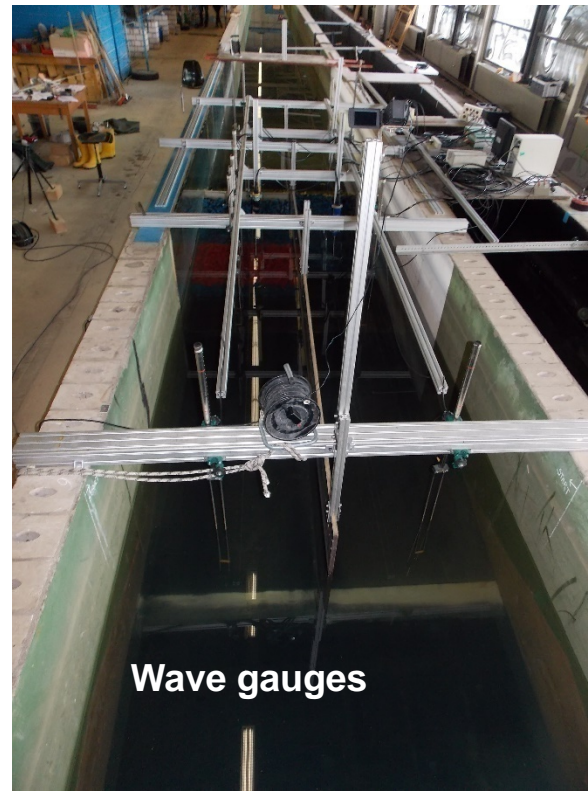
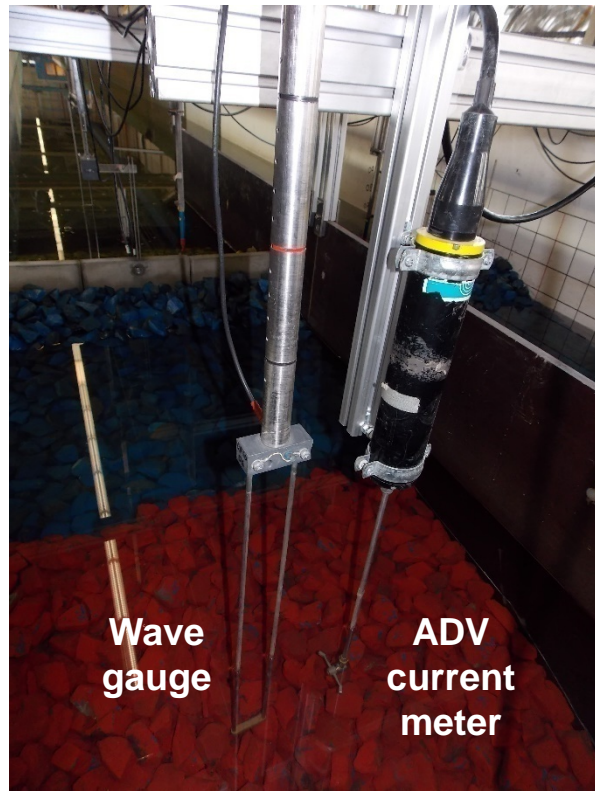

# Experimental phases

<b>Phase 1</b>	METU	Bore	Configuration 1, 2, 3, 4	July 2014
		Solitary wave	Configuration 1, 2 (partially)	
<b>Phase 2</b>	TU-BS (Student training)	Solitary wave	Configuration 1, 2 (completed)	August 2014
<b>Phase 3</b>	TU-BS	Solitary wave	Configuration 3, 4	January 2015

# Testing programme – Tsunami bore

Test no.	Configuration		Wave type	Water depth	
	Left part of wave flume [No.]	Right part of wave flume [No.]		In front of bore gate [m]	Behind bore gate [m]
20140721_01 20140721_02 20140721_03	3	4	Tsunami bore	0.200	0.750 0.800 0.850
20140723_01 20140723_02	1	2	Tsunami bore	0.200	0.750 0.800

Configuration 1: crown wall and berm  
Configuration 2: without crown wall

Configuration 3: crown wall  
Configuration 4: shifted crown wall



# Testing programme – Solitary wave

Test no.	Configuration		Wave type	Wave height [m]	Water depth [m]
	Left part of wave flume [No.]	Right part of wave flume [No.]			
20140725_01	1	2	Solitary wave	0.050	0.660
20140725_02				0.075	
20140807_01				0.100	
20140807_02				0.125	
20140807_03				0.150	
20150106_01	3	4	Solitary wave	0.050	0.660
20150106_02				0.075	
20150107_01				0.100	
20150108_01				0.125	
20150108_02				0.150	

Configuration 1: crown wall and berm  
Configuration 2: without crown wall

Configuration 3: crown wall  
Configuration 4: shifted crown wall

# Content

1. Motivation and objectives
2. Experimental set-up and programme
- 3. Results**
4. Conclusions

# Experiments with solitary wave vs. experiments with bore

## Solitary wave

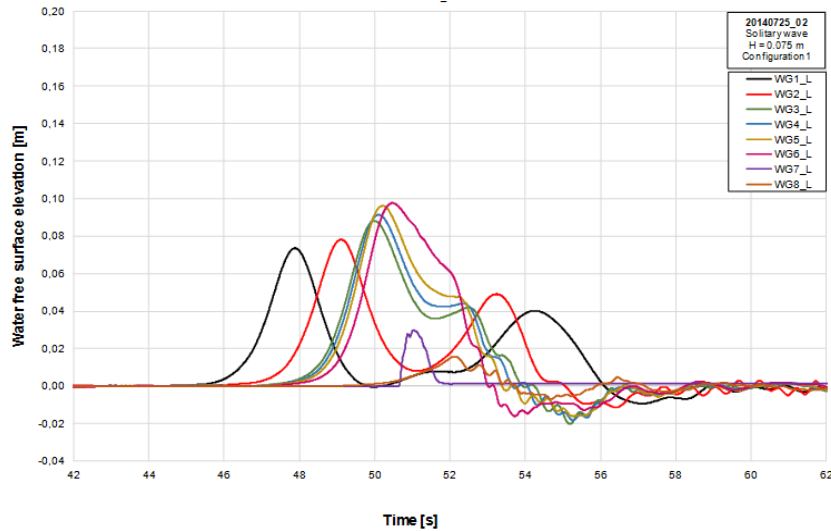

## Bore

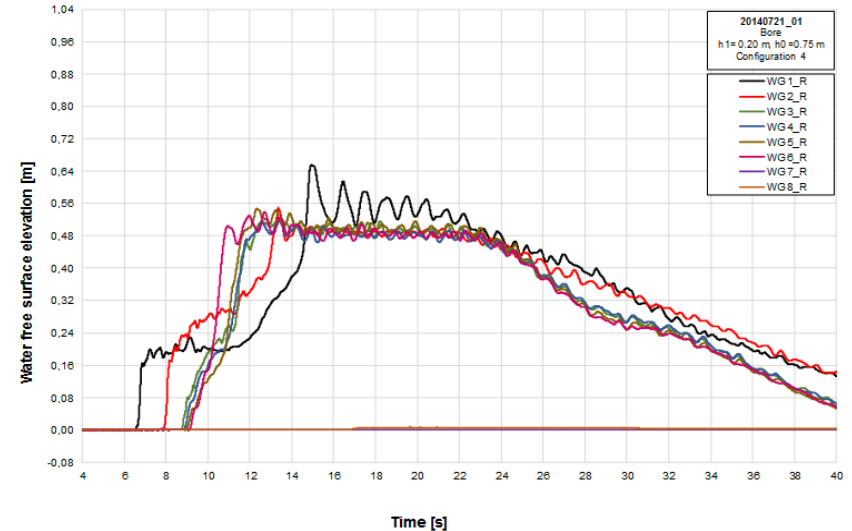

	Solitary wave	Bore
<b>Impact duration</b>	6 s	33 s
<b>Damage cause</b>	Overflow	Pressure difference on seaside and harbour side (flow through breakwater body)
<b>Water conditions</b>	Breakwater submerged ( $h = 0.66$ m)	Breakwater emerged

# Analysis of results for experiments with solitary wave



# Observed processes – solitary wave

H	Breakwater configuration			
	1	2	3	4
0.050 m	No overflow	Overflow	No overflow	No overflow
0.075 m	Overflow	Overflow	Overflow	Overflow
0.100 m	Overflow	Overflow	Overflow	Overflow
0.125 m	Overflow	Overflow	Overflow	Overflow
0.150 m	Overflow	Overflow	Overflow	Overflow

Configuration 1: crown wall and berm  
Configuration 2: without crown wall

Configuration 3: crown wall  
Configuration 4: shifted crown wall

# Observed damage – solitary wave (1)

H	Breakwater configuration			
	1	2	3	4
0.050 m	No damage	No damage	No damage	No damage
0.075 m	No damage	No damage	Minor damage	Minor damage
0.100 m	Minor damage	Minor damage	Minor damage	Major damage
0.125 m	Minor damage	Minor damage	Medium damage	Major damage
0.150 m	Major damage	Major damage	Major damage	Major damage











**Minor damage** – Some stones moved, crown element did not move

**Medium damage** – Many stones moved, crown element hardly moved

**Major damage** – Many stones moved, crown element moved

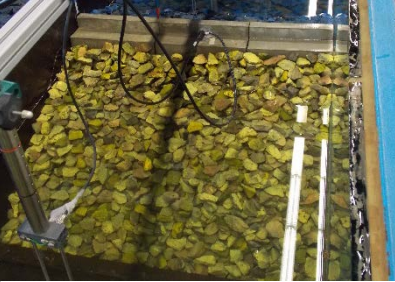
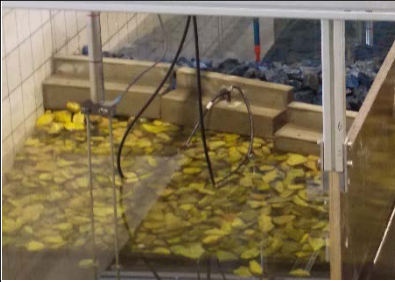
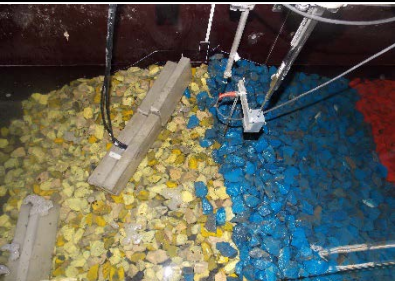

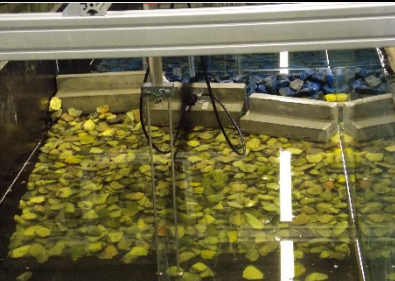
# Observed damage – solitary wave (2)

H	Breakwater configuration			
	1	2	3	4
0.050 m				
0.100 m				
0.150 m				



# Damage profiles (1): $H = 0.100$ m

## Configuration 1

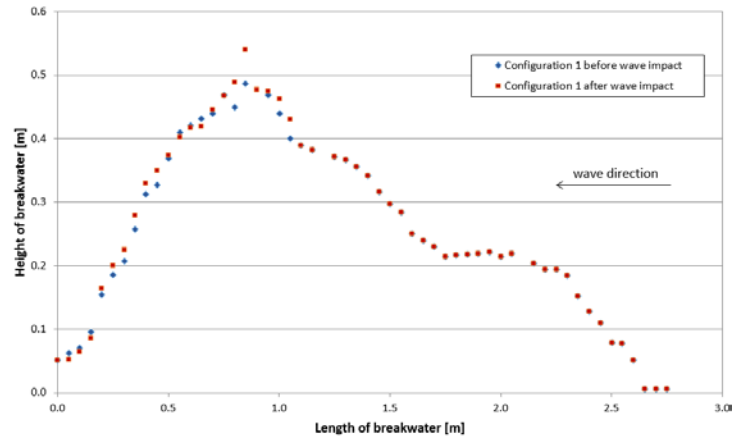

## Configuration 2

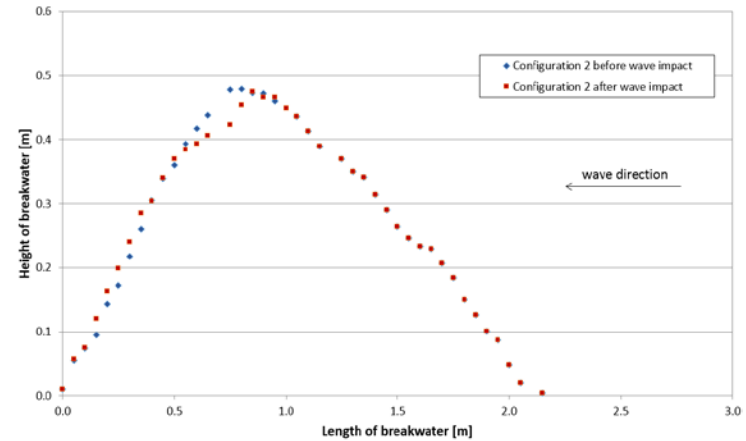

## Configuration 3

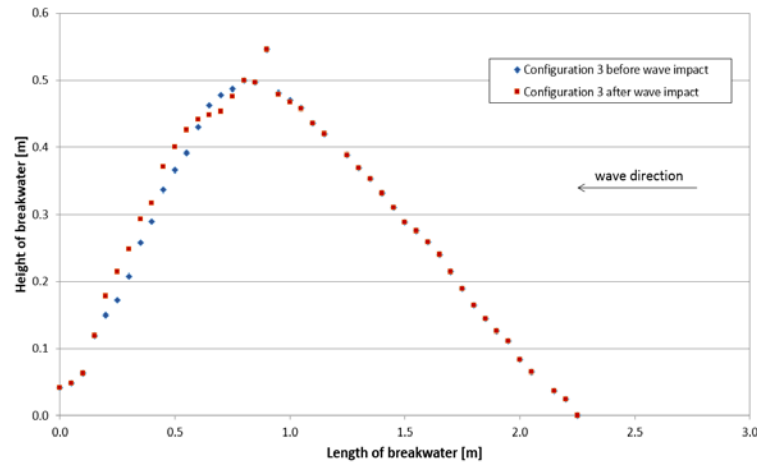

## Configuration 4

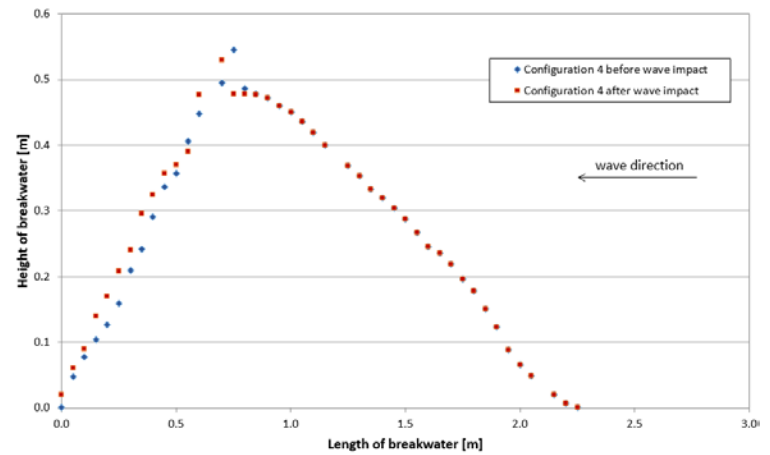

# Damage profiles (2): $H = 0.150$ m

## Configuration 1

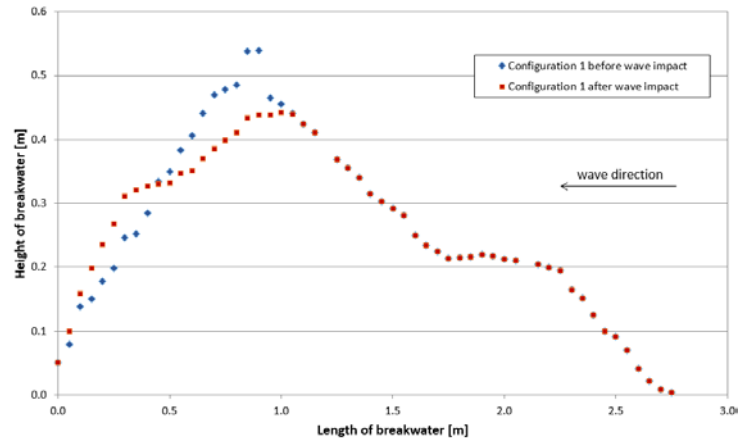

## Configuration 2

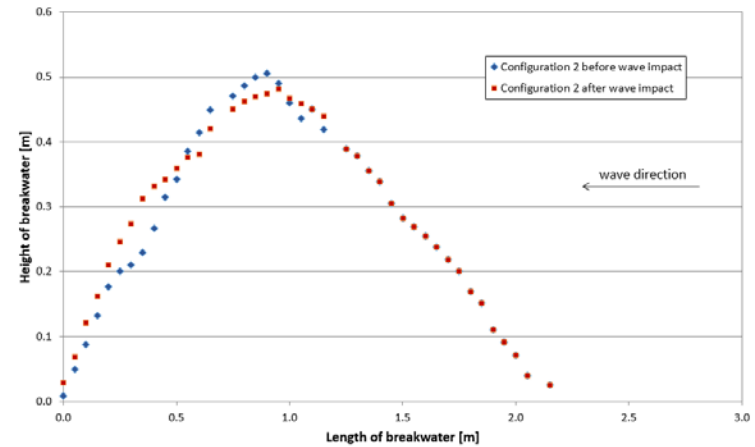

## Configuration 3

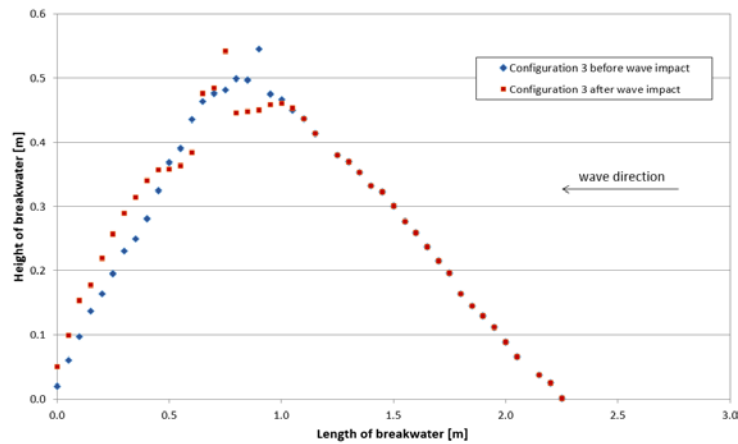

## Configuration 4

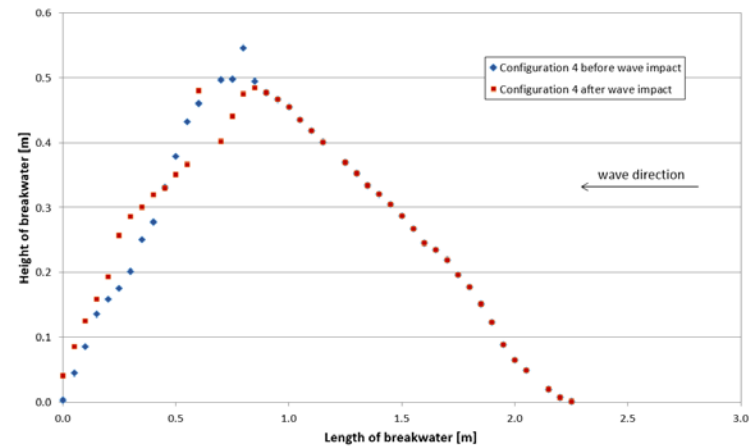

# Max. solitary wave height (1)

H	Breakwater configuration											
	1			2			3			4		
	WG 6	WG 7	WG 8	WG 6	WG 7	WG 8	WG 6	WG 7	WG 8	WG 6	WG 7	WG 8
0.050 m	0.070	no overflow	0.007	0.075	0.023	0.010	0.075	no overflow	0.007	0.076	no overflow	0.008
0.075 m	0.098	0.030	0.016	0.104	0.056	0.033	0.106	0.031	0.013	0.108	0.029	0.015
0.100 m	0.122	0.063	0.046	0.130	0.070	0.066	0.138	0.072	0.048	0.140	0.059	0.053
0.125 m	0.150	0.114	0.084	0.160	0.092	0.094	0.170	0.104	0.096	0.171	0.063	0.082
0.150 m	0.176	0.121	0.109	0.188	0.128	0.111	0.201	0.120	0.119	0.202	0.070	0.116

# Max. solitary wave height (2): $H = 0.100$ m

## Configuration 1

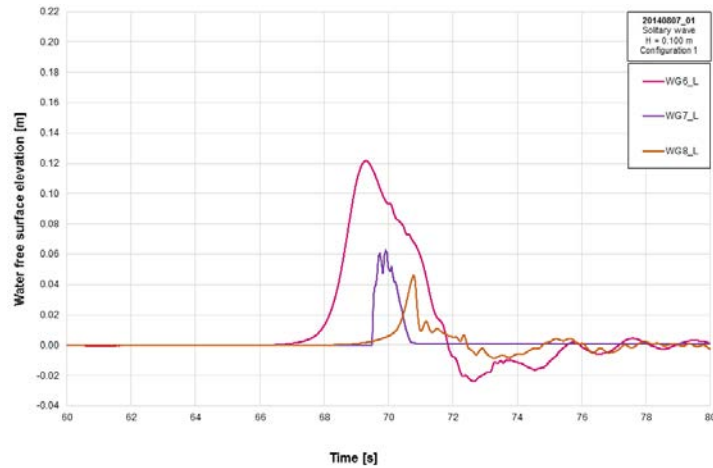

## Configuration 2

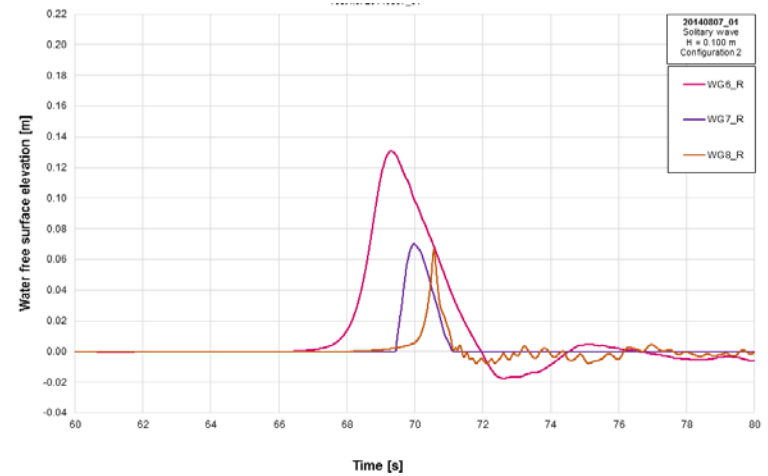

## Configuration 3

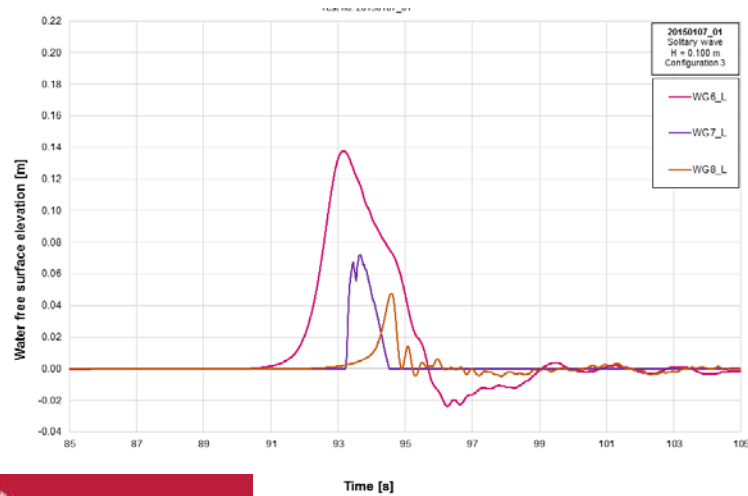

## Configuration 4

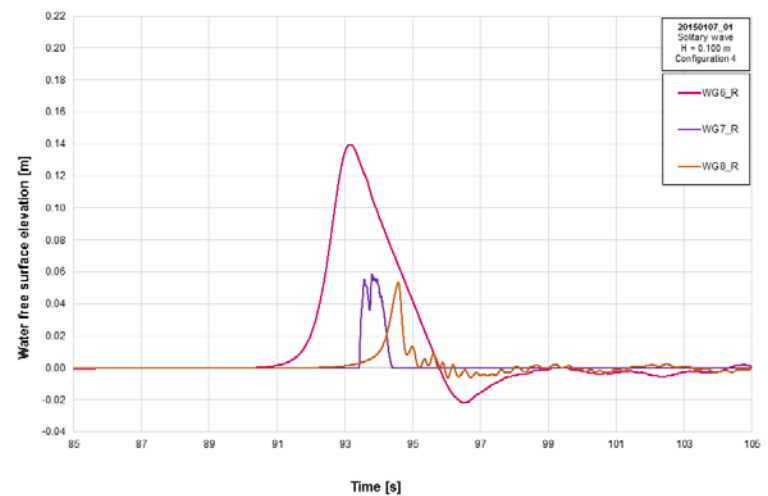

# Max. solitary wave height (3): $H = 0.150$ m

## Configuration 1

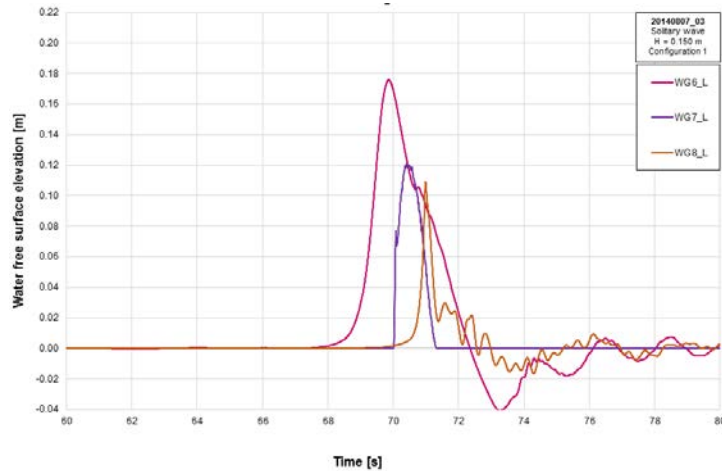

## Configuration 2

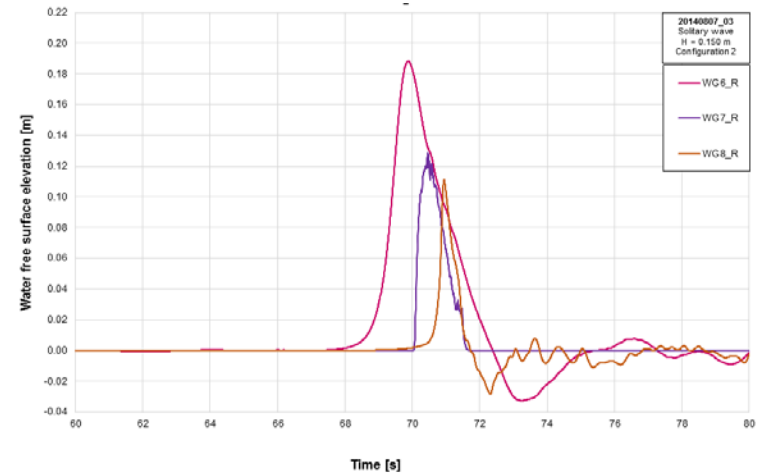

## Configuration 3

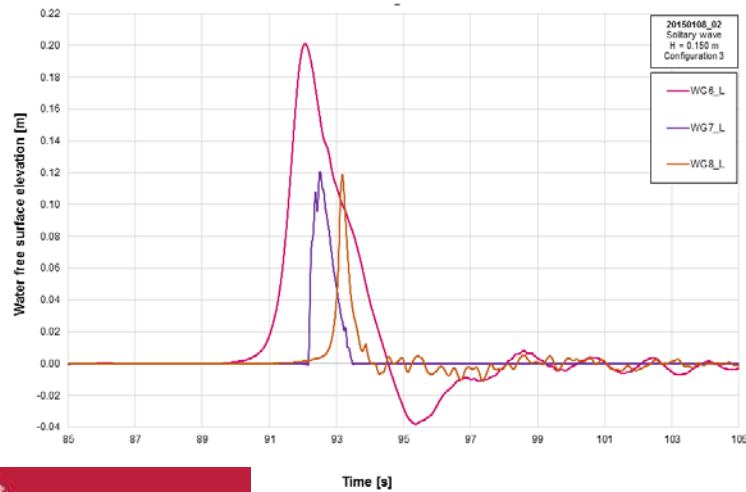

## Configuration 4

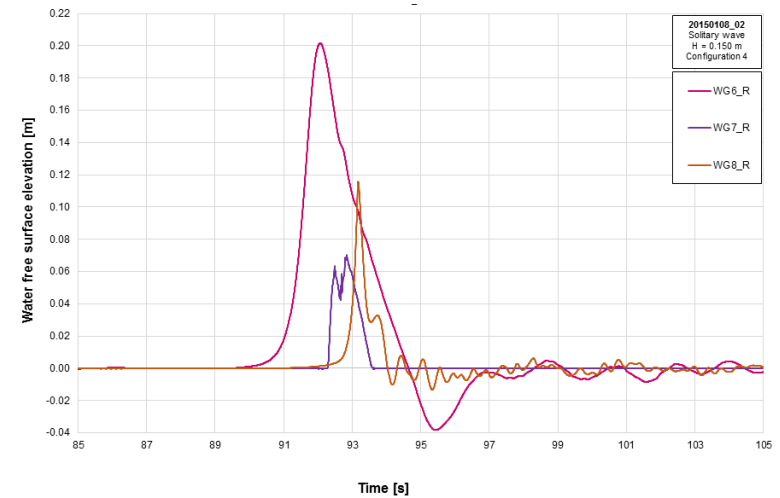

# Max. solitary wave induced pressure (1)

H	Breakwater configuration							
	1		2		3		4	
	PS 1	PS 2	PS 1	PS 2	PS 1	PS 2	PS 1	PS 2
0.050 m	0.739	0.169	not installed	not installed	0.491	- 0.289	0.195	- 0.603
0.075 m	1.006	0.667	not installed	not installed	0.804	- 1.026	0.698	- 0.778
0.100 m	1.189	1.000	not installed	not installed	1.193	- 1.614	1.076	- 1.366
0.125 m	1.274	1.350	not installed	not installed	1.384	- 2.063	1.432	- 1.639
0.150 m	1.354	1.530	not installed	not installed	1.441	- 2.417	1.709	- 1.883

# Max. solitary wave induced pressure (2): H = 0.100 m

## Configuration 1

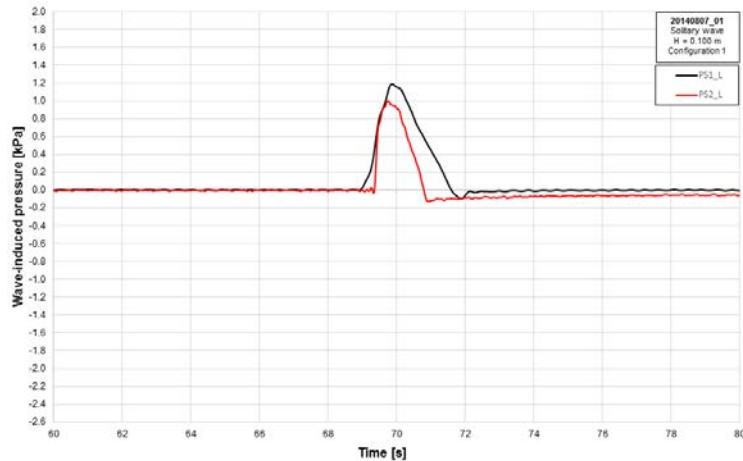

## Configuration 3

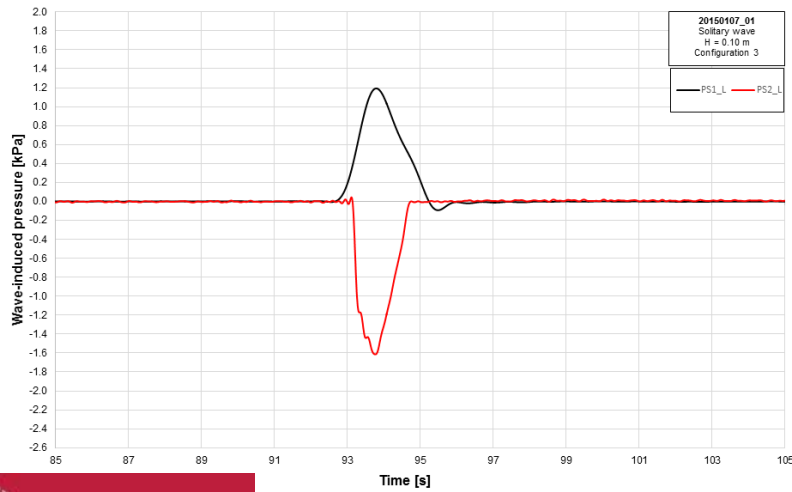

## Configuration 4

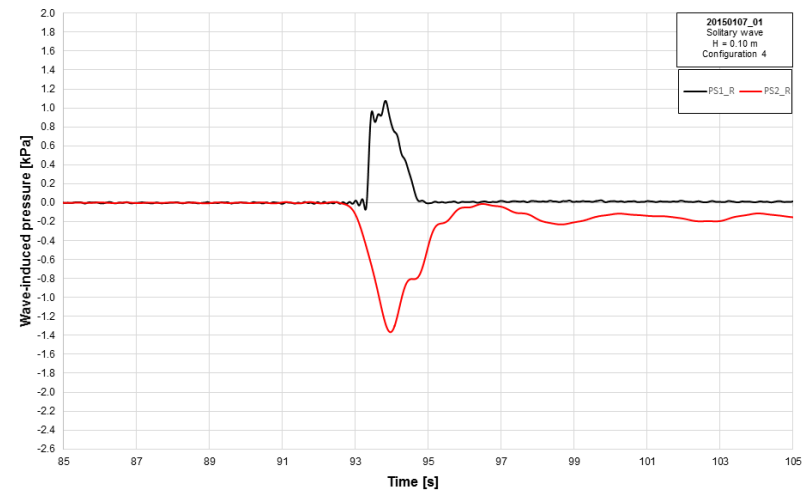



# Max. solitary wave induced pressure (3): $H = 0.150$ m

## Configuration 1

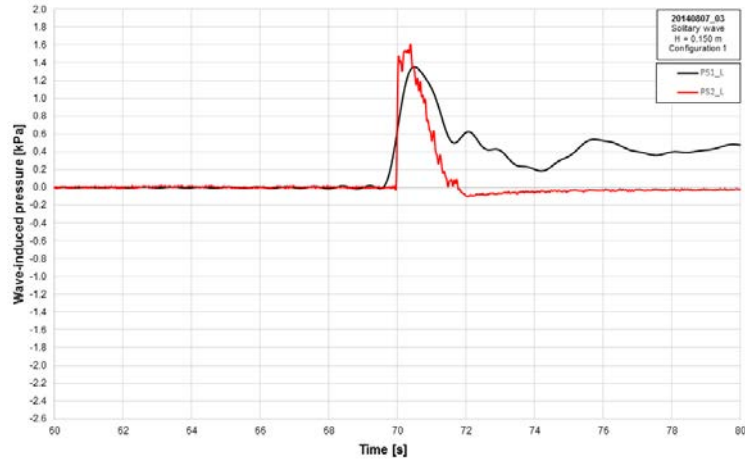

## Configuration 3

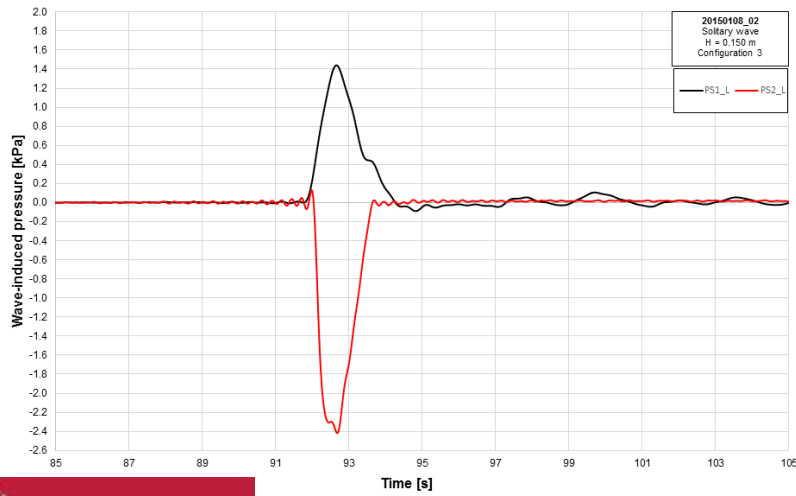

## Configuration 4

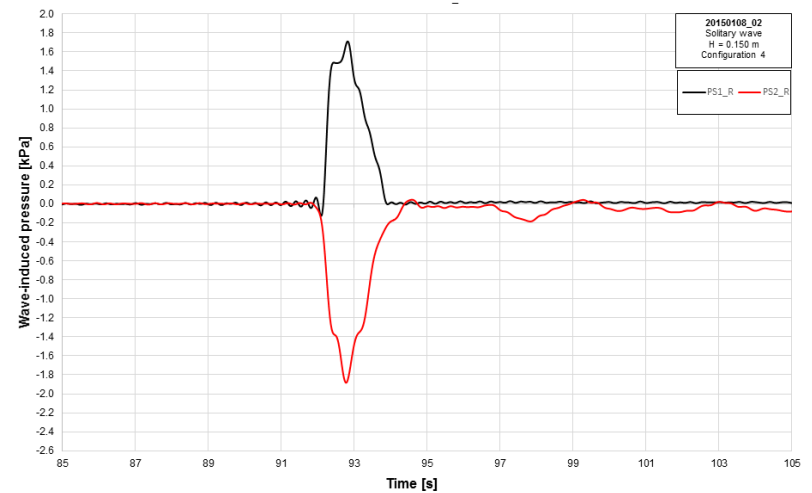

# Max. flow velocity under solitary wave/velocity at overtopping (1)

H	Breakwater configuration							
	1		2		3		4	
	ADV	PR	ADV	PR	ADV	PR	ADV	PR
0.050 m	-	no overflow	0.150	not working	0.094	no overflow	0.081	no overflow
0.075 m	0.250	0.135	0.150	not working	0.173	0.226	0.162	0.235
0.100 m	0.400	0.245	0.280	not working	0.218	0.371	0.218	0.385
0.125 m	0.450	0.292	0.380	not working	0.230	0.416	0.249	0.361
0.150 m	0.750	0.314	0.490	not working	0.280	0.416	0.291	0.402

# Max. flow velocity under solitary wave/velocity at overtopping (2): $H = 0.100$ m

## Configuration 1

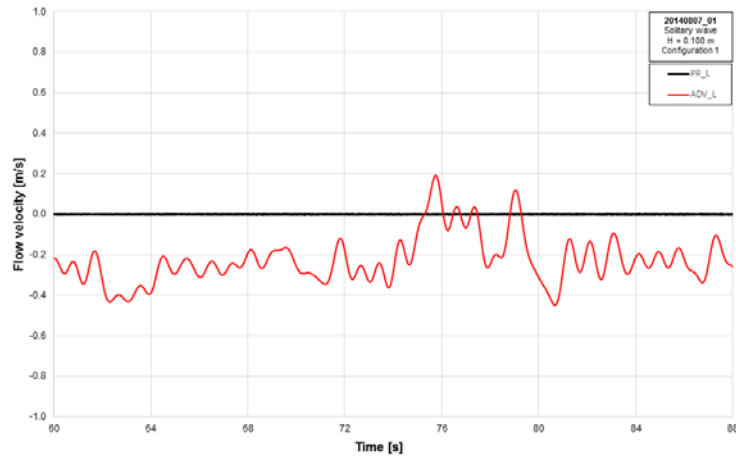

## Configuration 2

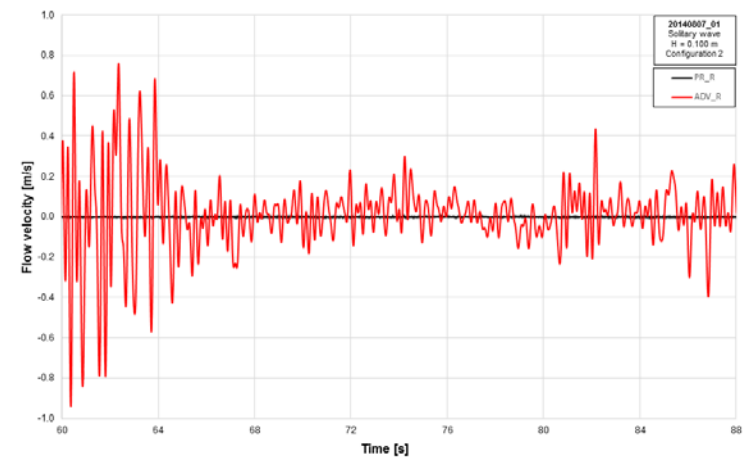

## Configuration 3

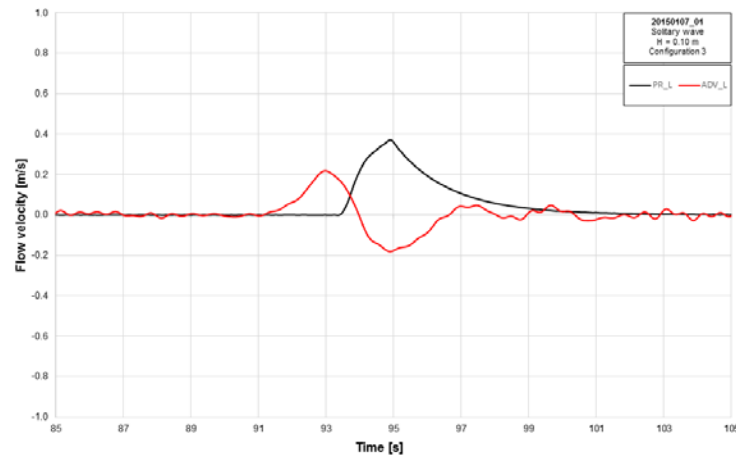

## Configuration 4

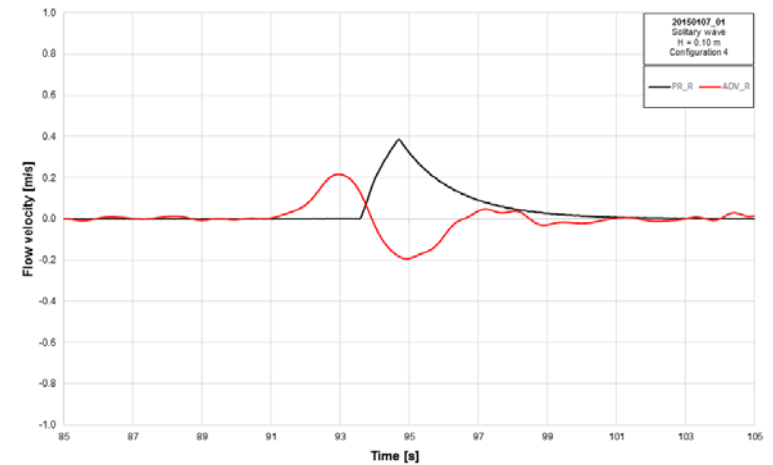

# Max. flow velocity under solitary wave/velocity at overtopping (3): $H = 0.150\text{ m}$

Configuration 1

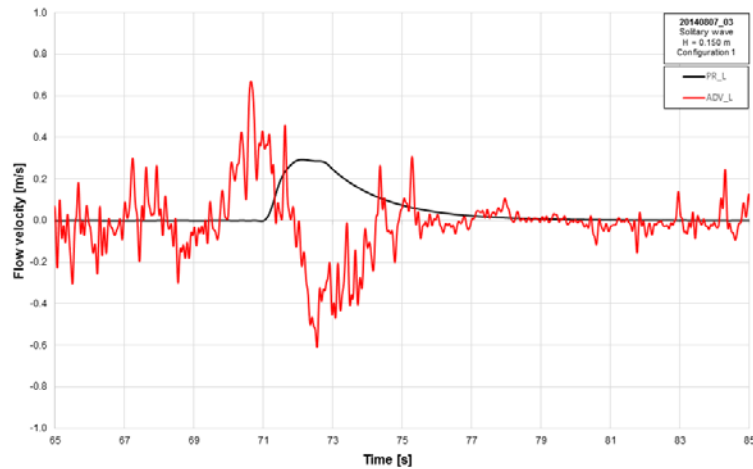

Configuration 2

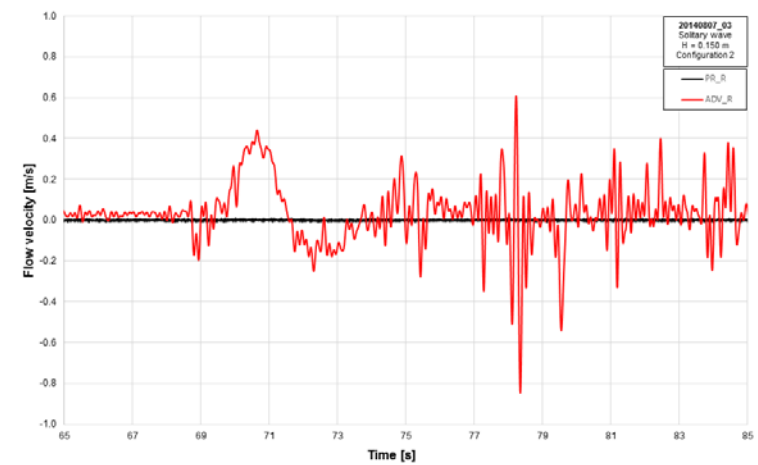

Configuration 3

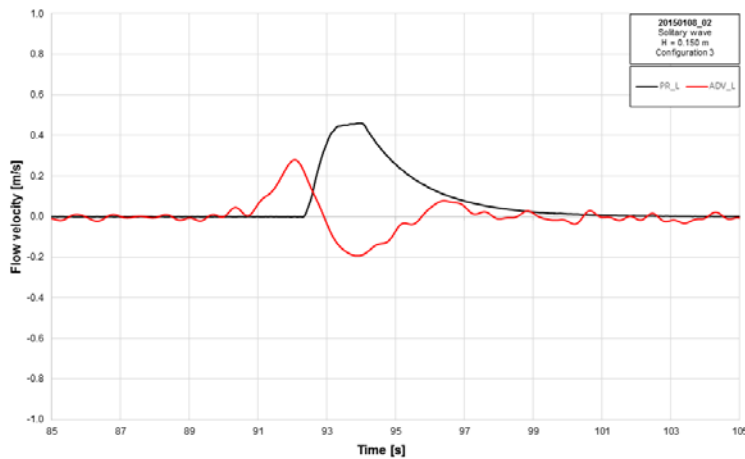

Configuration 4

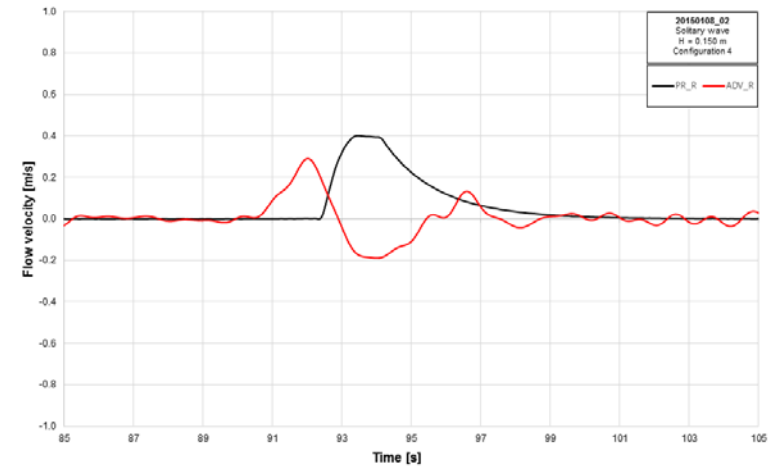

# Analysis of results for experiments with tsunami bore



# Observed processes – tsunami bore

$h_0, h_1$	Breakwater configuration			
	1	2	3	4
0.2 m, 0.75 m	No overflow*	No overflow*	No overflow*	No overflow*
0.2 m, 0.80 m	-	-	Weak overflow*	No overflow*
0.2 m, 0.85 m	Overflow*	Overflow*	Overflow*	Overflow*

\*flow through breakwater could be observed

# Observed damage – tsunami bore

$h_0, h_1$	Breakwater configuration			
	1	2	3	4
<b>0.2 m, 0.75 m</b>	Minor damage	Minor damage	No damage	No damage
<b>0.2 m, 0.80 m</b>	-	-	Minor damage	Minor damage
<b>0.2 m, 0.85 m</b>	Major damage*	Major damage*	Total failure	Total failure

\*due to flow through breakwater



# Damage profiles : $h_o = 0.8$ m

## Configuration 1

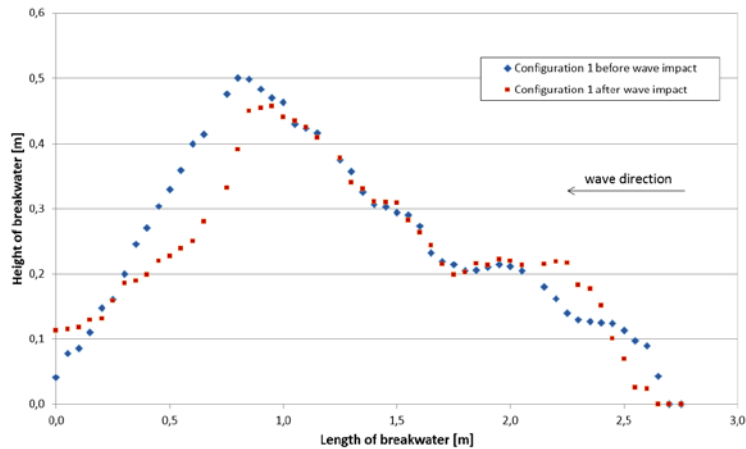

## Configuration 2

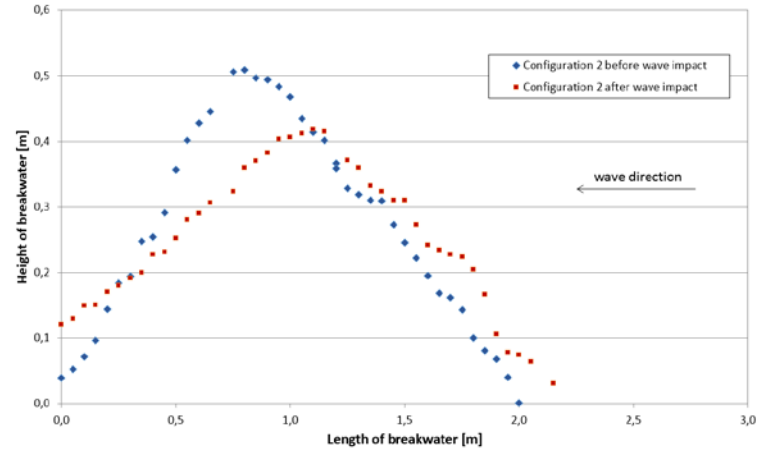

## Configuration 3

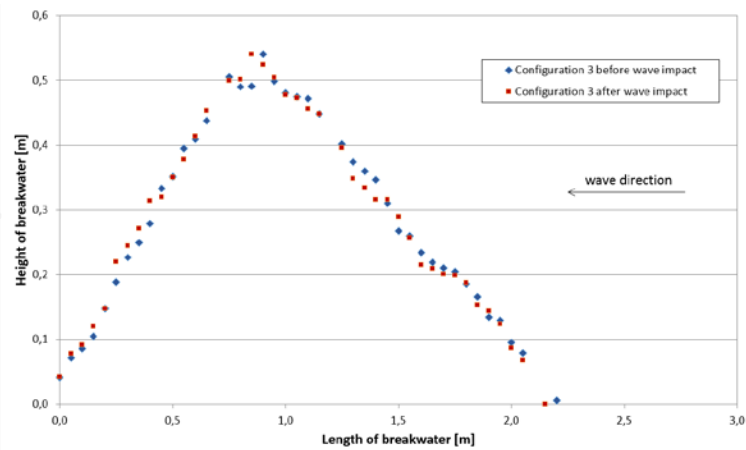

## Configuration 4

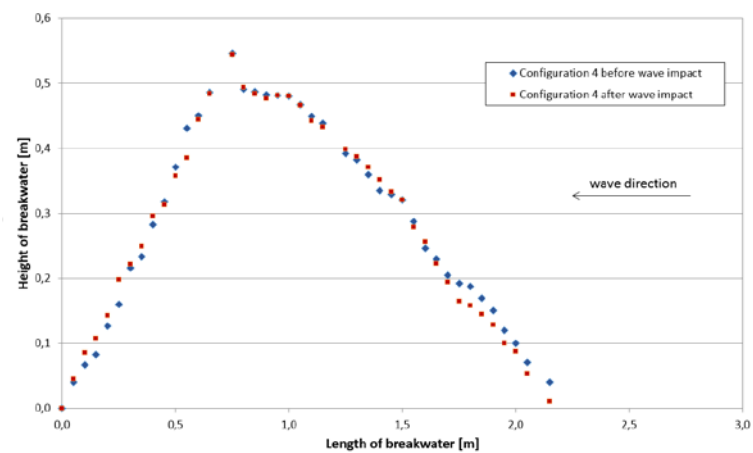

# Content

1. Motivation and objectives
2. Experimental set-up and programme
3. Results
4. Conclusions

# Conclusions

- Experiments with tsunami bore not very realistic (the breakwaters were emerged)

In tests with solitary wave impact:

- Largest wave overtopping attributed to configuration 2 (without crown wall element)  
-> inclusion of the crown wall element necessary
- No significant influence of the presence of the berm on the breakwater performance
- Configuration 4 (with shifted crown wall element) most unstable
- No damage to seaside breakwater slope
- Recommendation: double layer at the harbour slope -> experiments at PARI

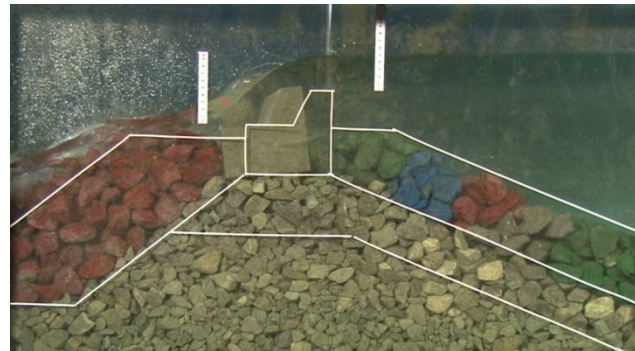

# Thank you all for the great engagement and effort!!!!







Thank you for your attention

Dr.-Ing. Andreas Kortenhaus

Dr.-Ing. Agnieszka Strusińska-Correia

Leichtweiß-Institute for Hydraulic Engineering and Water Resources  
Department of Hydromechanics and Coastal Engineering  
TU Braunschweig, Germany

andreas.kortenhaus@ugent.be  
a.strusinska@tu-bs.de